

### PART NUMBER CODING

#### Separate Rotor & Brush Block Assembly

##### COMPLETE ASSEMBLY

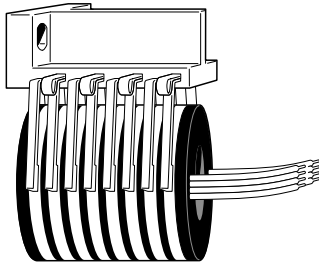

**2BR**

\*\*Two (2) Brushes per Ring

**Example:**

P/N 1908-2BR-FAG180

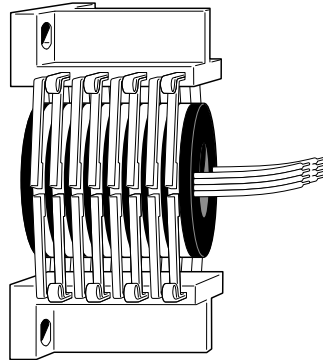

**4BR**

\*\*Four (4) Brushes per Ring

**Example:**

P/N 1908-4BR-FAG180

##### COMPLETE ASSEMBLY PART NUMBER CODING:

Type	Number of Brushes per Ring	Brush Grade Number	Options (If Applicable)
X	X	X	X
Slip Ring Type (see pages 1 thru 4)	** (2BR or 4BR)	* (FAG180)	(10 amp, Vacuum, etc.)

##### SEPARATE COMPONENTS

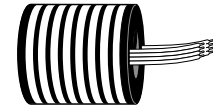

**Example:** P/N 1908-1

##### ROTOR PART NUMBER CODING:

Type	Universal Rotor Designation	Options (If Applicable)
X	1	X
Slip Ring Type (see pages 1 thru 4)	(Designation always - 1)	

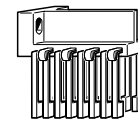

**Example:** P/N 1908-2-FAG180

##### BRUSH BLOCK PART NUMBER CODING:

Type	Universal Brush Block Designation	Brush Grade Number
X	2	X
Slip Ring Type (see pages 1 thru 4)	(Designation always - 2)	* (FAG180)

\* Consult Fabricast for optional brush grades and characteristics (see page 14).  
\*\* Refer to pages 1 thru 4 for electrical characteristics of 2BR and 4BR.

#### Self-Contained Assembly

##### COMPLETE ASSEMBLY

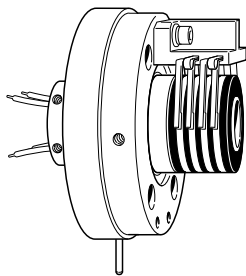

**2BR**

\*\*Two (2) Brushes per Ring

**Example:**

P/N 0984-2BR-FAG180

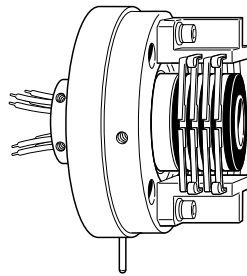

**4BR**

\*\*Four (4) Brushes per Ring

**Example:**

P/N 0984-4BR-FAG180

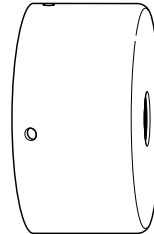

**COVER**

(included with self-contained assembly)

##### COMPLETE ASSEMBLY PART NUMBER CODING:

Type	Number of Brushes per Ring	Brush Grade Number	Options (If Applicable)
X	X	X	X
Slip Ring Type (see pages 5 thru 8)	** (2BR or 4BR)	* (FAG180)	(10 amp, Vacuum, etc.)

##### SEPARATE COMPONENT

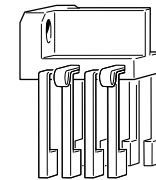

**Example:** P/N 0984-2-FAG180

##### BRUSH BLOCK PART NUMBER CODING:

Type	Universal Brush Block Designation	Brush Grade Number
X	2	X
Slip Ring Type (see pages 5 thru 8)	(Designation always - 2)	* (FAG180)

\* Consult Fabricast for optional brush grades and characteristics (see page 14).  
\*\* Refer to pages 5 thru 8 for electrical characteristics of 2BR and 4BR.

**Fabricast, Inc.**® MANUFACTURER OF SLIP RING ASSEMBLIES

TELEPHONE: (626) 443-3247  
FAX: (626) 443-5594  
E-MAIL: info@fabricast.com  
WEB SITE: www.fabricast.com